

MasterCut

Tool Corp.

World Class Manufacturer
of Rotary Cutting Tools



V4

High Performance Variable Helix

Fractional and Metric

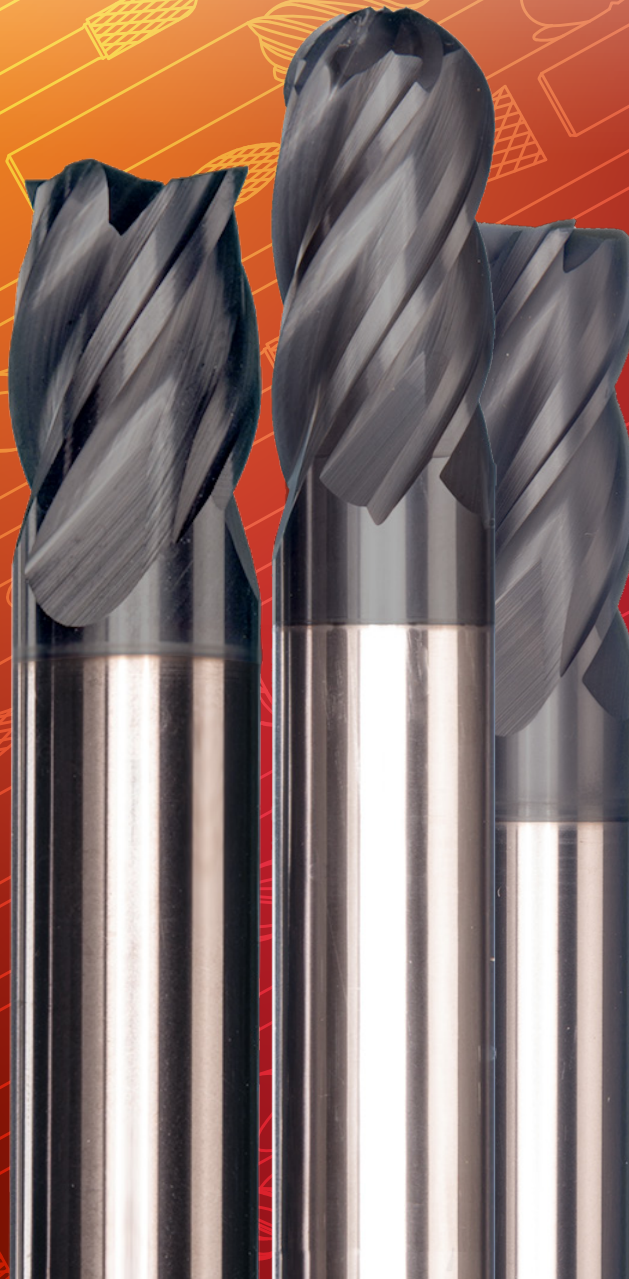

- **Chatter Free Parts**
- **Faster Feed Rates**
- **Longer Tool Life**
- **PowerA Coated**

Fractional Standard Length

4 Flute • PowerA Coated

Corner Radius, Square and Ball

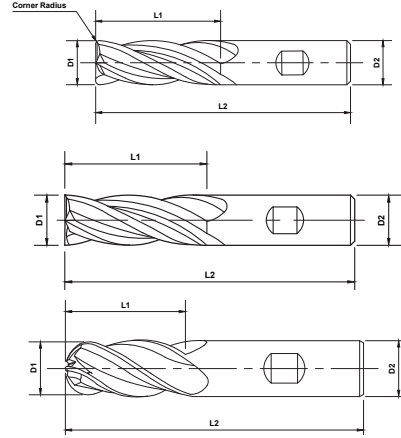
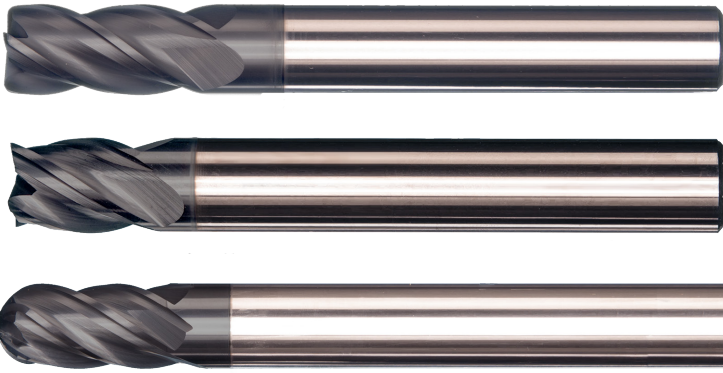

OD	LOC	SHK	OAL	CR in.	Corner Radius		Square		Ball	
D1	L1	D2	L2	R	No Flat	With Flat	No Flat	With Flat	No Flat	With Flat
1/8	3/8	1/8	1-1/2	.015	400-401-1	400-401W-1	400-002-1	400-002W-1	400-202-1	400-202W-1
3/16	7/16	3/16	2	.015	400-411-1	400-411W-1	400-006-1	400-006W-1	400-206-1	400-206W-1
1/4	5/8	1/4	2-1/2	.020	400-422-1	400-422W-1	400-010-1	400-010W-1	400-210-1	400-210W-1
5/16	13/16	5/16	2-1/2	.020	400-432-1	400-432W-1	400-012-1	400-012W-1	400-212-1	400-212W-1
3/8	7/8	3/8	2-1/2	.020	400-442-1	400-442W-1	400-016-1	400-016W-1	400-216-1	400-216W-1
7/16	1	7/16	2-3/4	.020	400-452-1	400-452W-1	400-020-1	400-020W-1	400-220-1	400-220W-1
1/2	1	1/2	3	.030	400-463-1	400-463W-1	400-022-1	400-022W-1	400-222-1	400-222W-1
1/2	1-1/4	1/2	3	.030	400-473-1	400-473W-1	400-024-1	400-024W-1	400-224-1	400-224W-1
9/16	1-1/8	9/16	3-1/2	.030	400-483-1	400-483W-1	400-026-1	400-026W-1	400-226-1	400-226W-1
5/8	1-1/4	5/8	3-1/2	.040	400-807-1	400-807W-1	400-028-1	400-028W-1	400-228-1	400-228W-1
3/4	1-1/2	3/4	4	.040	400-808-1	400-808W-1	400-030-1	400-030W-1	400-230-1	400-230W-1
3/4	1-5/8	3/4	4	.040	400-815-1	400-815W-1	400-032-1	400-032W-1	400-232-1	400-232W-1
1	1-1/2	1	4	.040	400-816-1	400-816W-1	400-034-1	400-034W-1	400-234-1	400-234W-1

Mastercut Tool Corp. does not recommend adding a weldon flat on tools with a shank diameter under 1/4". Call Customer Service for any additional Corner Radius requirements that you may have.



Metric Standard Length

4 Flute • PowerA Coated

Corner Radius, Square and Ball

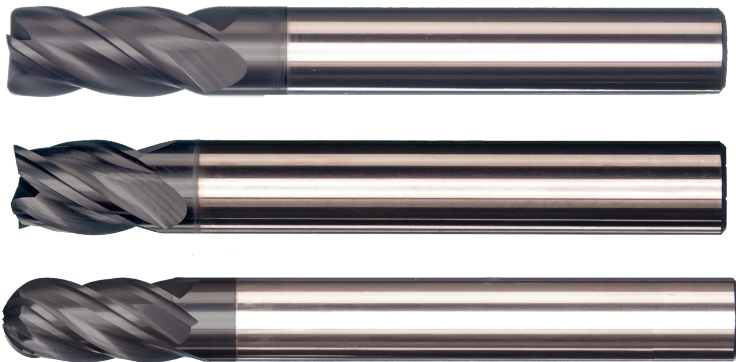

- High Performance **A-Gr-SiV** submicron grain carbide
- Unique variable design for faster speeds and feeds
- Quiet operation and better finish
- Proprietary AlTiN coating
- h6 shank Tolerances
- MAP certified quality
- V4 is **not** recommended for Aluminum

OD	LOC	SHK	OAL	CR mm	Corner Radius		Square		Ball	
D1	L1	D2	L2	R	No Flat	With Flat	No Flat	With Flat	No Flat	With Flat
3	12	3	38	.25	500-400-1	500-400W-1	500-002-1	500-002W-1	500-202-1	500-202W-1
4	14	4	50	.25	500-420-1	500-420W-1	500-008-1	500-008W-1	500-208-1	500-208W-1
5	16	5	50	.25	500-440-1	500-440W-1	500-014-1	500-014W-1	500-214-1	500-214W-1
6	19	6	63	.5	500-461-1	500-461W-1	500-018-1	500-018W-1	500-218-1	500-218W-1
8	19	8	63	.5	500-471-1	500-471W-1	500-020-1	500-020W-1	500-220-1	500-220W-1
10	22	10	70	.5	500-481-1	500-481W-1	500-022-1	500-022W-1	500-222-1	500-222W-1
12	25	12	75	.75	500-492-1	500-492W-1	500-024-1	500-024W-1	500-224-1	500-224W-1
14	25	14	88	.75	500-502-1	500-502W-1	500-026-1	500-026W-1	500-226-1	500-226W-1
16	32	16	88	.75	500-512-1	500-512W-1	500-028-1	500-028W-1	500-228-1	500-228W-1
18	36	18	100	.75	500-522-1	500-522W-1	500-030-1	500-030W-1	500-230-1	500-230W-1
20	38	20	100	.75	500-532-1	500-532W-1	500-032-1	500-032W-1	500-232-1	500-232W-1
25	38	25	100	.75	500-542-1	500-542W-1	500-034-1	500-034W-1	500-234-1	500-234W-1

Mastercut Tool Corp. does not recommend adding a weldon flat on tools with a shank diameter under 6mm. Call Customer Service for any additional Corner Radius requirements that you may have.

See the Mastercut website for even More Performance and Tool Life with the Mastercut Ultra V4 Endmills with PowerN and PowerNR Coatings

Email: sales@mastercuttool.com
www.mastercuttool.com

MasterCut
 Tool Corp.

Fractional Stub Length

4 Flute • PowerA Coated

Corner Radius, Square and Ball

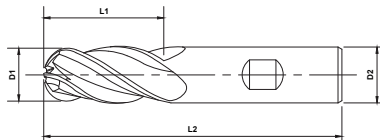
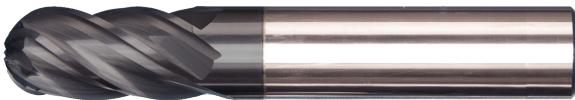
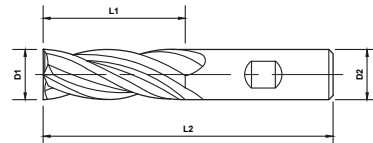
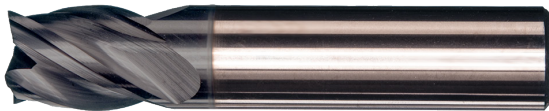
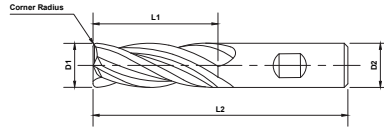
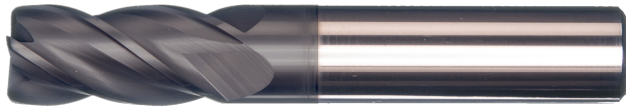

OD	LOC	SHK	OAL	CR in	Corner Radius		Square		Ball	
					No Flat	With Flat	No Flat	With Flat	No Flat	With Flat
1/8	1/4	1/8	1-1/2	.015	402-401-1	402-401W-1	402-004-1	402-004W-1	402-204-1	402-204W-1
5/32	5/16	3/16	2	.015	402-411-1	402-411W-1	402-002-1	402-002W-1	402-202-1	402-202W-1
3/16	3/8	3/16	2	.015	402-421-1	402-421W-1	402-006-1	402-006W-1	402-206-1	402-206W-1
7/32	7/16	1/4	2	.015	402-431-1	402-431W-1	402-008-1	402-008W-1	402-208-1	402-208W-1
1/4	1/2	1/4	2	.020	402-442-1	402-442W-1	402-010-1	402-010W-1	402-210-1	402-210W-1
5/16	1/2	5/16	2	.020	402-452-1	402-452W-1	402-012-1	402-012W-1	402-212-1	402-212W-1
3/8	5/8	3/8	2	.020	402-462-1	402-462W-1	402-014-1	402-014W-1	402-214-1	402-214W-1
7/16	5/8	7/16	2-1/2	.020	402-472-1	402-472W-1	402-016-1	402-016W-1	402-216-1	402-216W-1
1/2	5/8	1/2	2-1/2	.030	402-483-1	402-483W-1	402-018-1	402-018W-1	402-218-1	402-218W-1
5/8	3/4	5/8	3	.040	402-804-1	402-804W-1	402-020-1	402-020W-1	402-220-1	402-220W-1
3/4	1	3/4	4	.040	402-806-1	402-806W-1	402-024-1	402-024W-1	402-224-1	402-224W-1

Mastercut Tool Corp. does not recommend adding a weldon flat on tools with a shank diameter under 1/4". Call Customer Service for any additional Corner Radius requirements that you may have.

See the Mastercut website for even *More Performance and Tool Life* with the Mastercut *Ultra V4 Endmills* with PowerN and PowerNR Coatings



Metric Stub Length

4 Flute • PowerA Coated

Corner Radius, Square and Ball

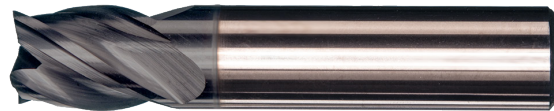
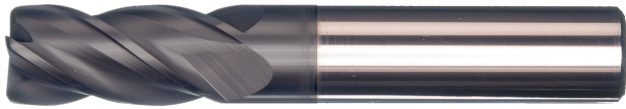

- High Performance **A-Gr-SiV** submicron grain carbide
- Unique variable design for faster speeds and feeds
- Quiet operation and better finish
- Proprietary AlTiN coating
- h6 shank tolerances
- MAP certified quality
- V4 is **not** recommended for Aluminum

OD	LOC	SHK	OAL	CR mm	Corner Radius		Square		Ball	
					No Flat	With Flat	No Flat	With Flat	No Flat	With Flat
3	6	3	38	.25	502-401-1	502-401W-1	502-002-1	502-002W-1	502-202-1	502-202W-1
4	8	4	50	.25	502-410-1	502-410W-1	502-004-1	502-004W-1	502-204-1	502-204W-1
5	10	5	50	.25	502-420-1	502-420W-1	502-006-1	502-006W-1	502-206-1	502-206W-1
6	12	6	50	.50	502-431-1	502-431W-1	502-008-1	502-008W-1	502-208-1	502-208W-1
8	12	8	50	.50	502-451-1	502-451W-1	502-012-1	502-012W-1	502-212-1	502-212W-1
10	14	10	50	.50	502-461-1	502-461W-1	502-014-1	502-014W-1	502-214-1	502-214W-1
12	16	12	63	.75	502-472-1	502-472W-1	502-016-1	502-016W-1	502-216-1	502-216W-1

Mastercut Tool Corp. does not recommend adding a weldon flat on tools with a shank diameter under 6mm. Call Customer Service for any additional Corner Radius requirements that you may have.



Customers' Needs Come First

CNC 1st Team

Customers' Needs Come First! This is what truly matters to us. To ensure you the fastest possible service, we have assembled simulation, engineering, production scheduling, and inventory personnel into one unit, wherein they can collaborate on any and all special requests from you, the moment your request is received. They are dedicated and qualified to assist you with solutions, fast!

Email: sales@mastercuttool.com
www.mastercuttool.com



Fractional Long Length

4 Flute • PowerA Coated

Corner Radius, Square and Ball

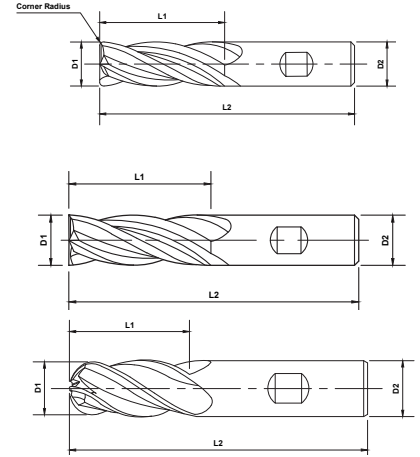
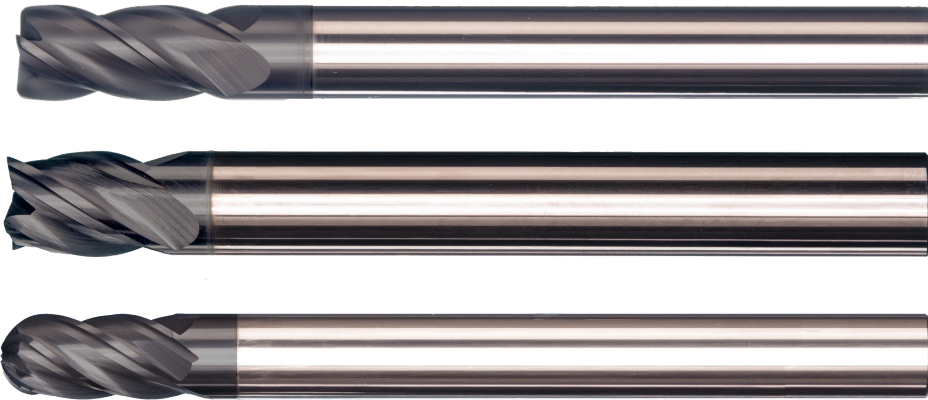

OD D1	LOC L1	SHK D2	OAL L2	CR in. R	Corner Radius		Square		Ball	
					No Flat	With Flat	No Flat	With Flat	No Flat	With Flat
1/4	1-1/8	1/4	3	.020	401-402-1	401-402W-1	401-002-1	401-002W-1	401-202-1	401-202W-1
5/16	1-1/8	5/16	3	.020	401-412-1	401-412W-1	401-004-1	401-004W-1	401-204-1	401-204W-1
3/8	1-1/8	3/8	3	.020	401-422-1	401-422W-1	401-006-1	401-006W-1	401-006-1	401-006W-1
1/2	2	1/2	4	.030	401-433-1	401-433W-1	401-008-1	401-008W-1	401-008-1	401-008W-1
5/8	2-1/4	5/8	5	.035	401-801-1	401-801W-1	401-010-1	401-010W-1	401-010-1	401-010W-1
3/4	2-1/4	3/4	5	.035	401-802-1	401-802W-1	401-012-1	401-012W-1	401-012-1	401-012W-1

Mastercut Tool Corp. does not recommend adding a weldon flat on tools with a shank diameter under 1/4". Call Customer Service for any additional Corner Radius requirements that you may have.

The "MAP" to Your Success!



Our continuous improvement has led us to a process that gives you unmatched, consistent quality. That process is our unique MAP Technology! Mastercut Automated Production is our exclusive method of standardization and quality repeatability. The MAP combines technology, skill, and rigid processes to provide you with the most precise products that money can buy, batch to batch and year to year.

Our MAP...your map to success!



Metric Long Length

4 Flute • PowerA Coated

Corner Radius, Square and Ball

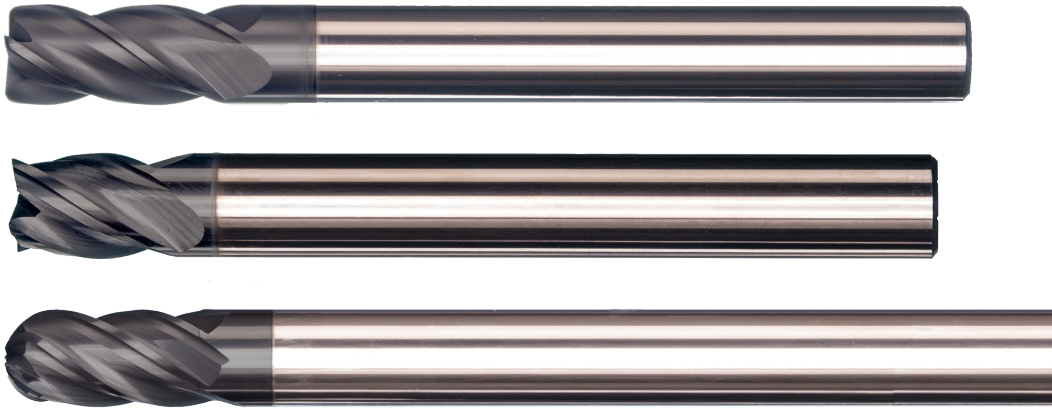

- High Performance **A-Gr-SiV** submicron grain carbide
- Unique variable design for faster speeds and feeds
- Quiet operation and better finish
- Proprietary AlTiN coating
- h6 shank tolerances
- MAP certified quality
- V4 is **not** recommended for Aluminum

OD	LOC	SHK	OAL	CR mm	Corner Radius		Square		Ball	
D1	L1	D2	L2	R	No Flat	With Flat	No Flat	With Flat	No Flat	With Flat
3	20	3	65	.25	501-400-1	501-400W-1	501-002-1	501-002W-1	501-202-1	501-202W-1
4	20	4	65	.25	501-410-1	501-410W-1	501-004-1	501-004W-1	501-204-1	501-204W-1
5	20	5	75	.25	501-420-1	501-420W-1	501-006-1	501-006W-1	501-206-1	501-206W-1
6	25	6	75	.50	501-431-1	501-431W-1	501-008-1	501-008W-1	501-208-1	501-208W-1
8	25	8	75	.50	501-441-1	501-441W-1	501-010-1	501-010W-1	501-210-1	501-210W-1
10	38	10	100	.50	501-451-1	501-451W-1	501-012-1	501-012W-1	501-212-1	501-212W-1
12	50	12	100	.75	501-462-1	501-462W-1	501-014-1	501-014W-1	501-214-1	501-214W-1
14	56	14	125	.75	501-472-1	501-472W-1	501-016-1	501-016W-1	501-216-1	501-216W-1

Mastercut Tool Corp. does not recommend adding a weldon flat on tools with a shank diameter under 6mm. Call Customer Service for any additional Corner Radius requirements that you may have.

See the Mastercut website for even *More Performance and Tool Life* with the Mastercut Ultra V4 Endmills with PowerN and PowerNR Coatings

Fractional Speed and Feed Recommendations

Material	Surface Feet Per Min.	Chip Load Per Tooth (CLPT)			
		1/8	1/4	1/2	1
Aluminium Alloys	1,200	0.0010	0.0020	0.0040	0.0080
Carbon Steel	300 - 600	0.0010	0.0015	0.0030	0.0060
Cast Iron	350 - 550	0.0010	0.0015	0.0030	0.0060
Copper Alloys	500 - 900	0.0010	0.0020	0.0030	0.0060
Steel (Annealed)	350 - 500	0.0010	0.0020	0.0030	0.0050
Steel (18-24 HRC)	150 - 500	0.0004	0.0008	0.0015	0.0045
Steel (25-37 HRC)	125 - 200	0.0003	0.0005	0.0010	0.0030
Stainless Steel (Free Machining)	250 - 400	0.0005	0.0010	0.0020	0.0030
Stainless Steel (Other)	150 - 300	0.0005	0.0010	0.0020	0.0030
Inconel, Monel	60 - 100	0.0005	0.0010	0.0015	0.0030
Titanium	175 - 300	0.0005	0.0008	0.0015	0.0030

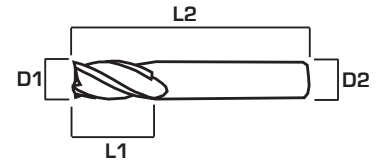

D1 - Cutting Diameter
L1 - Cutting Length
D2 - Shank Diameter
L2 - Overall Length

V4 Endmills are not recommended for Aluminum.

*Mastercut Tool Corp. does not recommend adding a weldon flat on tools with a shank diameter under 1/4". Recommended Maximum Loads- Slotting: 1 X's Diameter • Radial feed: 0.5 X's Diameter • Axial feed: 1.5 X's Diameter

Metric Speed and Feed Recommendations

Material	Surface Meters Per Min.	Chip Load Per Tooth (CPz)											
		.010-.020	.015-.025	.020-.025	.020-.035	.025-.050	.033-.050	.050-.075	.055-.080	.065-.090	.070-.095	.075-.100	.090-.115
Low Carbon Steel	90-185	.010-.020	.015-.025	.020-.025	.020-.035	.025-.050	.033-.050	.050-.075	.055-.080	.065-.090	.070-.095	.075-.100	.090-.115
Cast Iron	110-170	.013-.025	.025-.035	.025-.050	.025-.050	.038-.050	.040-.060	.045-.055	.050-.075	.055-.085	.065-.090	.070-.095	.080-.125
Alloy Steel (Annealed)	110-155	.013-.025	.025-.035	.030-.050	.040-.060	.050-.065	.060-.080	.070-.090	.075-.090	.075-.095	.080-.095	.085-.105	.100-.125
Alloy Steel (18-24 HRC)	45-155	.010-.020	.025-.035	.030-.050	.040-.060	.050-.065	.060-.080	.070-.090	.075-.090	.075-.095	.080-.095	.085-.105	.100-.125
Alloy Steel (25-37 HRC)	35-65	.010-.020	.020-.030	.025-.035	.030-.040	.035-.045	.040-.050	.045-.055	.050-.065	.055-.080	.075-.090	.085-.105	.090-.110
Stainless Steel (Free Machining)	75-125	.018-.025	.020-.025	.025-.030	.030-.040	.040-.050	.045-.055	.050-.065	.050-.070	.055-.075	.055-.080	.060-.080	.060-.085
Difficult Stainless Steel	45-90	.016-.023	.018-.023	.020-.028	.025-.035	.038-.045	.040-.050	.045-.060	.045-.065	.050-.070	.050-.075	.055-.075	.055-.080
Inconel, Monel	15-30	.010-.025	.020-.025	.025-.030	.025-.030	.030-.035	.030-.040	.035-.050	.040-.060	.045-.070	.045-.075	.050-.085	.060-.090
Titanium	55-90	.010-.025	.020-.025	.025-.030	.025-.030	.030-.035	.030-.040	.035-.050	.040-.060	.045-.070	.045-.075	.050-.085	.060-.090

*Mastercut Tool Corp. does not recommend adding a weldon flat on tools with a shank diameter under 6mm. Recommended Maximum Loads- Slotting: 1 X's Diameter • Radial feed: 0.5 X's Diameter • Axial feed: 1.5 X's Diameter



MASTERCUT TOOL CORP.
965 Harbor Lake Drive
Safety Harbor, Florida 34695
Ph [727] 726-5336
Fx [727] 725-2532
Email: sales@mastercuttool.com
www.mastercuttool.com

Distributed by:

